

Operating Instructions



PHILIPS



TABLE OF CONTENTS

Safety Information/Precaution	3
Hooking Up Your TV Use / Care of Remote Control	4
Checking the Supplied Accessories	5
Dressing the Cables	5
Monting Procedures for LCD TV.....	6
Connecting the Audio/Video Sockets (Playback) /(Recording)	7 – 8
Connecting the Audio Equipment, Amplifier and Subwoofer	9
Connecting the Headphone	9
Connecting the FM Radio Mains	9
Connecting the PC Equipment	10
Connecting the HD (High Definition) Equipment	10
Functions of Remote Control	11 – 12
Functions of TV Top Controls	13
Accessing the TV Main Menu and Sub-Menus.....	14
Overview of TV Main Menu and Sub-Menus	14 – 15
Overview of FM Radio Main Menu and Sub-Menus	16
Overview of PC Main Menu and Sub-Menus	17
Overview of HD Main Menu and Sub-Menus	18
Accessing the TV Installation Menu	
Choosing the Menu Language and Automatic Tuning of LCD TV Channels	19
Manual Tuning of LCD TV Channels	20
Selecting the Colour/Sound System.....	21
Fine Tuning of LCD TV Channels	22
Sorting of LCD TV Channels	23
Editing of LCD TV Channels	24
Naming of LCD TV Channels	25
Using the LCD TV Picture/Sound Menu	26
Accessing the TV Features Installation Menu	
Activating the Timer.....	27 – 28
Using the Mode Select	29
Activating the Child Lock.....	30 – 33
Using the Screen Formats	34
Activating the Sleeptimer.....	35
Activating the Active Control	35
Activating the TV Smart Picture /Sound Control	36
Using the Teletext.....	37 – 38
Accessing the FM Radio Installation Menu	
Language, Auto Store, Manual Store, Sort, Name	39
Using the FM Radio Sound Menu.....	40
Using the FM Radio Smart Sound Control.....	40
Accessing the FM Radio Features Menu	
Activating the Timer.....	41
Using the Mode Select	42
Activating the Screensaver.....	42
Accessing the PC Mode	43
PC Display Setup.....	44
Using the PC Picture-in-Picture Feature.....	44
PC Modes Support	45
Accessing the HD (High Definiton) Mode	
Using the HD Picture/Sound Menu	46
Using the HD Mode Select	47
Using the HD Lock Channel	47
Before Calling Service (TV Mode)	48
Before Calling Service (PC / FM Radio Mode)	49
Specifications.....	50



SAFETY INFORMATION

- Disconnect mains plug when :
 - the red light below the TV screen is flashing continuously.
 - cleaning the TV screen. Never use abrasive cleaning agents.
 - there is a lightning storm.
 - the set is left unattended for a prolonged period of time.
- No naked flame sources, such as lighted candles, should be placed on top of the TV or in the vicinity.
- Do not place your TV set under direct sunlight or heat.
- Leave at least 5 cm around each side of TV set to allow for proper ventilation.
- Avoid placing your set (e.g. near the window) where it is likely to be exposed to rain or water.
- No objects (such as vases) filled with liquids should be placed on top the TV so as to avoid dripping or splashing of liquids on the set.

PRECAUTION

- Do not shift or move the set around when it is switched on.
- Do not connect AC/DC adaptor to your set that does not originally comes with the set. Only use recommended part that is approved by Philips manufacturer.
- Caution : Do not use cover or enclose the AC/DC adaptor with any objects like a cloth or box which might shorten the life time of the equipment.
- Do not touch, push or rub the surface with hard object.
- When the surface becomes dusty, wipe gently with absorbent cotton or other soft materials like chamois, soak with petroleum benzene. Do not use acetone, toluene and acohol as it causes chemical damage to the polarizer.
- Wipe off saliva or water droplets as soon as possible. Long time contact with polarizar causes deformations and colour fading.
- Be careful of condensation at sudden temperature change. Condensation does damage to polarizar or electrical contact parts. After condensation fades, smear or spot will occur.



Recycling Directive – To minimise harm to the environment, the batteries supplied with the TV set do not contain mercury or nickel cadmium. If possible, when disposing of batteries, use recycling means available to you. Your TV set uses materials which are reusable or which can be recycled. To minimise the amount of waste in the environment, specialist companies recover used sets for dismantling and collection of reusable materials (contact your dealer).



HOOKING UP YOUR TV (BASIC CONNECTION)

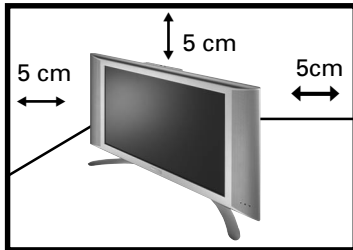

Positioning of the TV set

- Place your TV set on a solid base, strong enough to withstand the weight of the set.
- Leave a space of at least 5 cm around each side of the TV set to allow for proper ventilation.
- ^a Do not place TV set near a radiator or other sources of heat.
- Do not place TV set where it can be exposed to rain or excessive moisture.

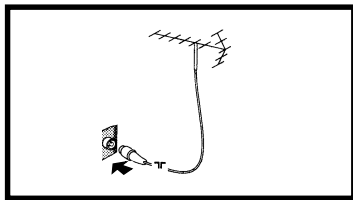

Antenna Connection

- Connect the aerial plug to the antenna socket  on the backcover.

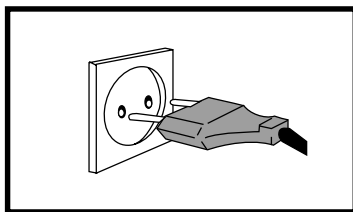

Mains Connection

- Insert the mains plug into the wall socket. For correct mains voltage, refer to type sticker at the rear of the adaptor.
 - Consult your dealer if mains supply is different.
- Note :** This diagram is not representative of the actual plug and socket.

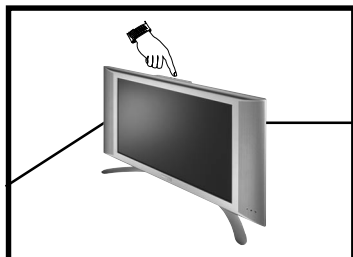

Switching on the Set

- Press the main power button on the top controls to switch on/off the TV.
- If the set is on standby (indicator is red), press the Power button on the remote control to switch on set.

USE/CARE OF REMOTE CONTROL

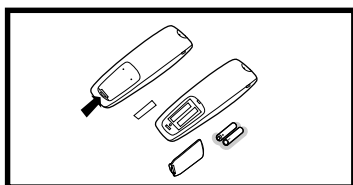

- Insert the correct type of batteries into the compartment.
- Ensure the batteries are placed in the right direction.

CHECKING THE SUPPLIED ACCESSORIES

The following accessories are supplied together with the LCD set.

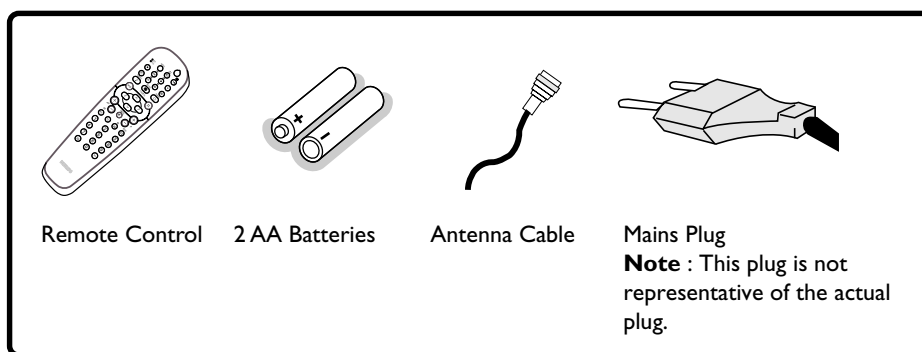

DRESSING THE CABLES



For better cable management, it is advisable to insert all cables through the hole of the stand as shown in the diagram after connecting to the respective connectors. For connection description, refer to sections on :

- Connecting the Audio/Video Sockets (Playback)
- Connecting the Audio/Video Sockets (Recording)
- Connecting to the Audio Equipment, Amplifier and Subwoofer
- Connecting to the Headphone
- Connecting to the FM Radio Mains
- Connecting the PC Equipment
- Connecting the HD (High Definition) Equipment



MOUNTING PROCEDURES FOR LCD TV

If you want to mount the LCD TV on any device, this set has four mounting interfaces fulfilling VESA specifications.



- 1) Lay the LCD TV face-down on a flat surface with a cushion or other soft material to protect the screen.
 - 2) Remove all cables connected on the TV.
 - 3) Remove the four screws and then remove the stand from the LCD TV.
 - 4) Screw in mounting plate. Reconnect all cables to the LCD TV.
- You are now ready to mount the device. Below is an example of adjusted ranges and mounting options (VESA compatible).

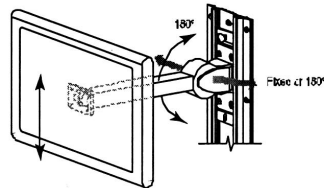

Option A:
Side mount to wall, Track, or machine

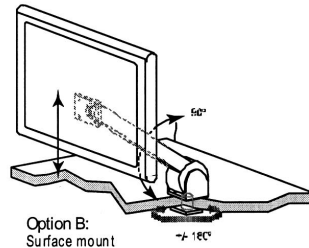

Option B:
Surface mount

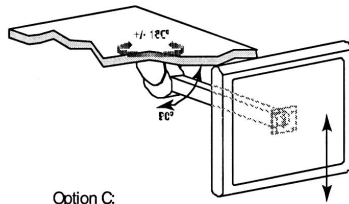

Option C:
Under surface over-head mount

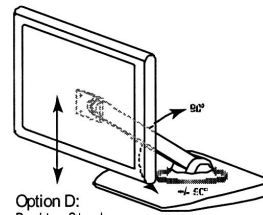

Option D:
Desktop Stand

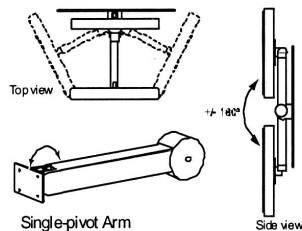

Single-pivot Arm

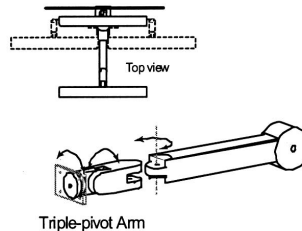

Triple-pivot Arm



CONNECTING THE AUDIO/VIDEO SOCKETS (PLAYBACK)

You can view the playback of VCR tapes (Video Disc players, camcorders, etc.) by using the AUDIO and VIDEO INPUT sockets on the rear of the TV.

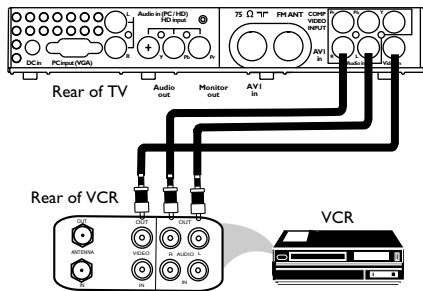

- Connect the **VIDEO** and **AUDIO IN** sockets on the rear of the LCD TV to the **AUDIO** and **VIDEO OUT** sockets on the VCR.

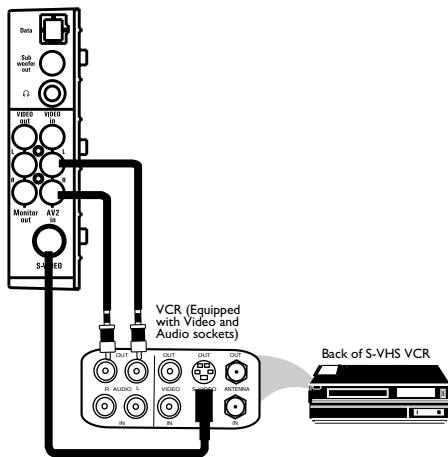

The S-Video connection on the Side of the LCD TV is used for the playback of S-VHS VCR tapes, Video Discs, Video Games or Compact Disc-Interactive (cd-i) discs. Better picture detail and clarity is possible with the S-Video playback as compared to the picture from a normal antenna (RF) connection.

- Connect the **S-VIDEO** socket on the side of the LCD TV to the **S-VHS OUT** socket on a S-VHS VCR.
- Connect the **AUDIO IN** sockets from the rear of the TV to the **AUDIO OUT** sockets on the VCR. **Note** : You need not connect the **VIDEO IN** socket of the LCD TV if **S-VIDEO IN** socket is connected.

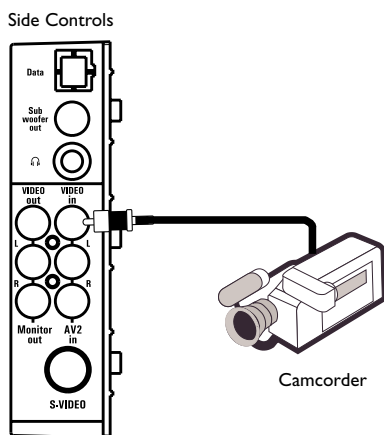

For more convenient direct playback connections, the Side Audio/Video Input sockets allow for quick and easy connections, particularly Camcorder tape recordings.

- Connect the **S-VIDEO** socket (if available) from the Camcorder to the Side **S-VIDEO** socket of the TV. You need not connect the Side **VIDEO IN** socket of the TV if the **S-VIDEO** socket is connected.
- Connect the **AUDIO OUT** sockets (Right and Left) from the Camcorder to the Side **AUDIO IN** sockets.



CONNECTING THE AUDIO/VIDEO SOCKETS (PLAYBACK)

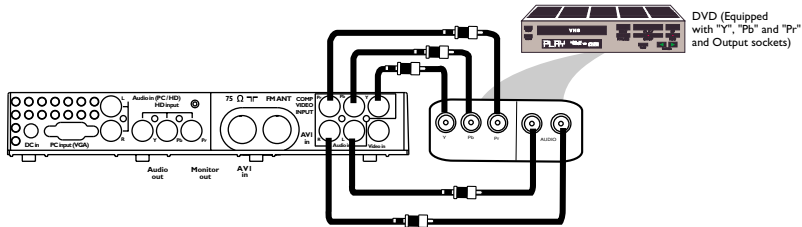

You can view the playback of DVD discs by using the **COMPONENT VIDEO INPUT** sockets at the rear of the LCD TV.

- Connect the "Y", "Pb" and the "Pr" sockets at the rear of the LCD TV to the "Y", "Pb" and "Pr" **OUTPUT** sockets of the DVD player to view playback of DVD discs.

CONNECTING THE AUDIO/VIDEO SOCKETS (RECORDING)

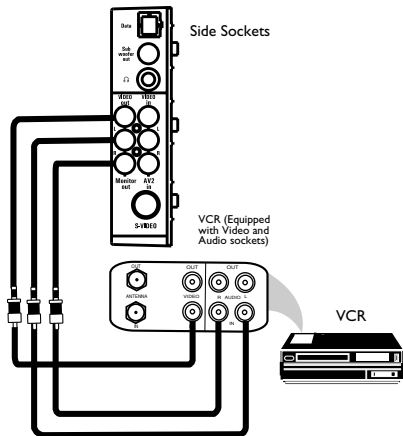

Connection for recording from the TV channel

- Connect the corresponding **INPUT** sockets of the VCR to the **MONITOR OUTPUT** sockets at the rear of the LCD TV.

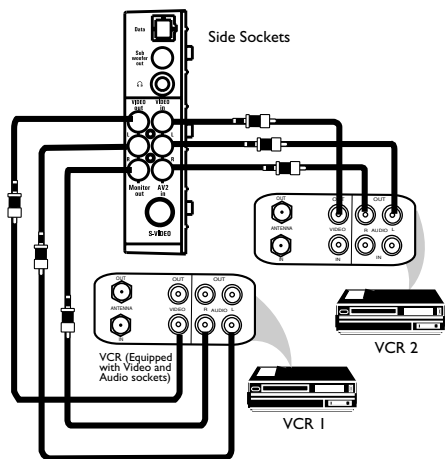

Connection for recording from one VCR to another VCR

- Connect the sockets of the VCR which you want to record from, to the corresponding sockets at AV2.
- Connect the sockets of the receiving VCR to the **MONITOR OUTPUT** sockets at the side of the LCD TV.





CONNECTING TO THE AUDIO EQUIPMENT, AMPLIFIER AND SUBWOOFER

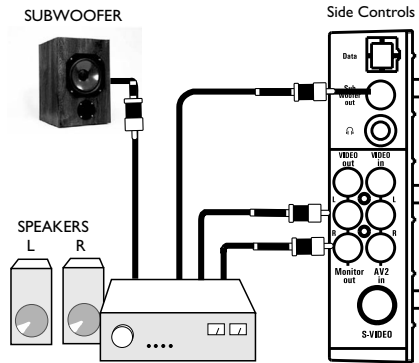

Connect the audio cable to the audio input of your audio equipment and to **AUDIO L** and **R** at the rear of the TV

If you have a subwoofer, connect the cable from Subwoofer Out socket to an external amplifier.

You can listen to your TV sound via your audio equipment.

Note : If you want to connect more equipment to your TV, consult your dealer.

CONNECTING TO THE HEADPHONE

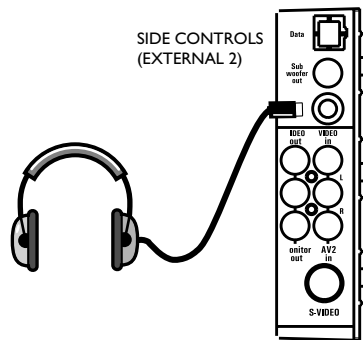

Insert the plug into the headphone socket  at the Side sockets of the LCD TV.

CONNECTING TO THE FM RADIO MAINS

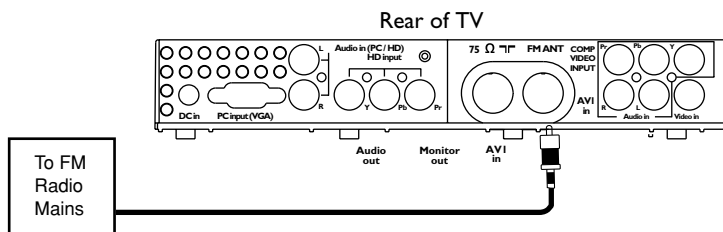

To enable you to access FM radio mode in the TV, you must connect from FM Antenna socket to the FM Radio mains.



CONNECTING THE PC EQUIPMENT

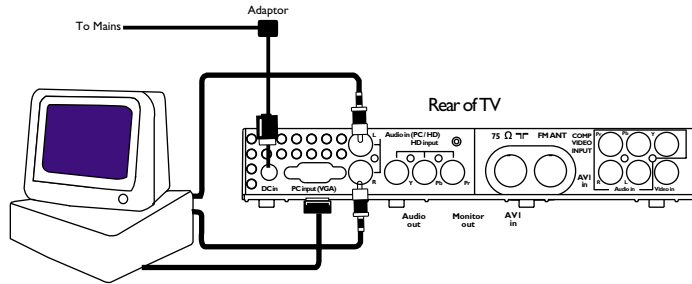

To enable you to access PC mode in the TV, you must connect the following :

- Connect adaptor from DC in to the mains.
- Connect the PC input (VGA) to the Monitor Output of your PC
- Connect Audio L and R output of your PC to the **Audio IN L** and **R** of your LCD TV.

CONNECTING THE HD (HIGH DEFINITION) EQUIPMENT

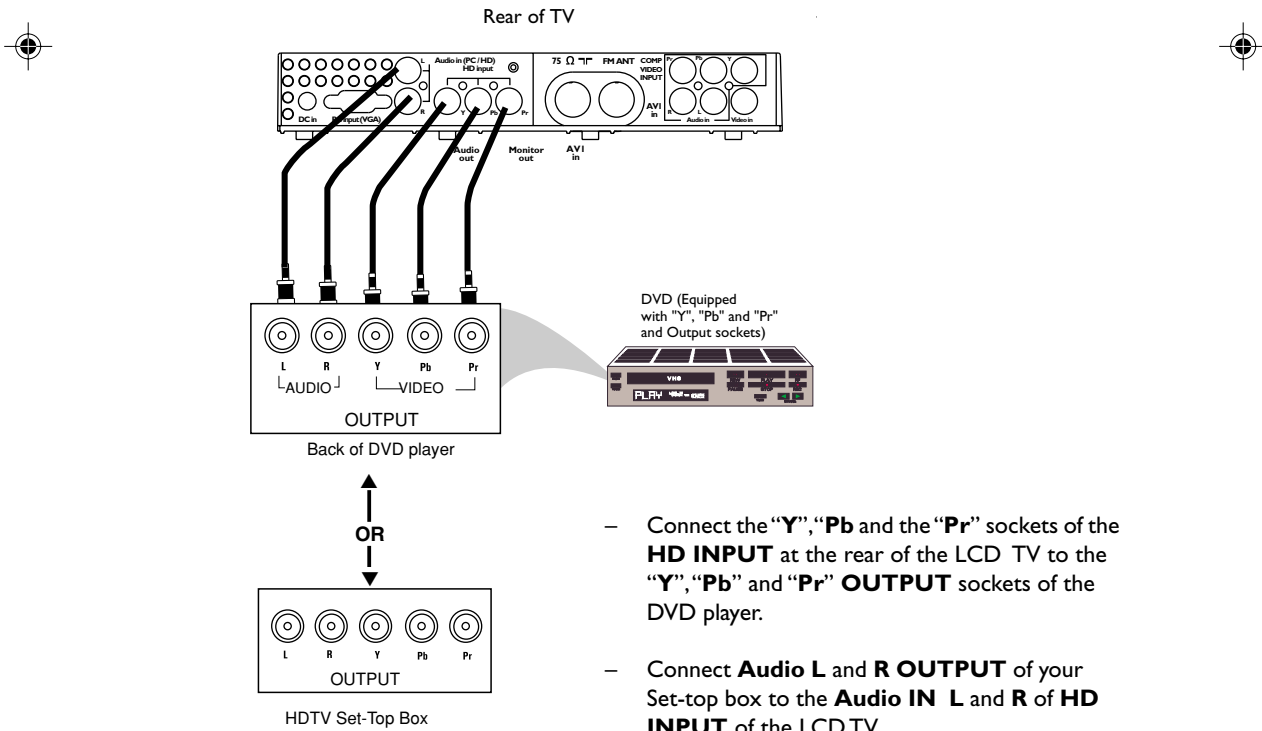

- Connect the **“Y”**, **“Pb”** and the **“Pr”** sockets of the **HD INPUT** at the rear of the LCD TV to the **“Y”**, **“Pb”** and **“Pr”** **OUTPUT** sockets of the DVD player.
- Connect **Audio L** and **R OUTPUT** of your Set-top box to the **Audio IN L** and **R** of **HD INPUT** of the LCD TV.



FUNCTIONS OF REMOTE CONTROL

1 POWER button

- Switch set off to standby mode. To switch on set from standby mode, press Channel +/- , Digit (0 -9) or Power button.

2 MODE button/VCR and DVD indicators

Press the Mode button repeatedly to choose between VCR or DVD mode. The VCR or DVD indicator will light up if selected. Once VCR or DVD mode is selected, it allows you access to the Record, Play, Stop, Pause, Forward and Rewind functions for your VCR or DVD player. **Note** : The set will switch to TV mode if there is no activity on any of the VCR/DVD buttons after 20 seconds.

3 VCR/DVD buttons

VCR/DVD buttons allows you access to the Record, Play, Stop, Forward and Rewind functions for your VCR or DVD player (Applicable to only certain models of PHILIPS). For these functions to be enabled, you must select VCR or DVD mode by the MODE button.

4 SLEEPTIMER button

It allows you to select a time period after which the set will switch to standby mode automatically. (Refer to section on "Activating the Sleep timer")

5 HI / TELETEXT button

- When in TV mode, it allows you to switch from Stereo to Mono sound during stereo transmission or to choose between language I or language II during dual sound transmission.
- When in teletext mode, allows you to display dual page text.

6 SMART SOUND button

Press the Smart Sound button repeatedly to access 4 different types of sound settings and choose your desired setting.

7 MENU button

Displays the main menu. Also exits menu from screen.

8 CURSOR LEFT/UP button

- Cursor Left button allows you to select the sub-menus and adjust the settings.
- Cursor Up button allows you to select the next item on the menu.

9 VOLUME + / - button

Increases or decreases volume.

10 TV button

When you are in PC, HD or FM Radio mode, press this button to enter into TV mode.

11 PC button

When you are in TV, HD or FM Radio mode, press this button to enter into PC mode.

12 INDEX/OSD button

- When in teletext mode, it functions as an Main Index button (Refer to section on "Using the Teletext").
- When in TV mode, press to exit on-screen menu. Also displays information like current channel number, sound mode, etc..

13 FORMAT / TIMER (VCR) button

In TV mode, it allows to select your desired screen format. Refer to section on ("Using the Screen Format"). Also allows you timer function in VCR mode.

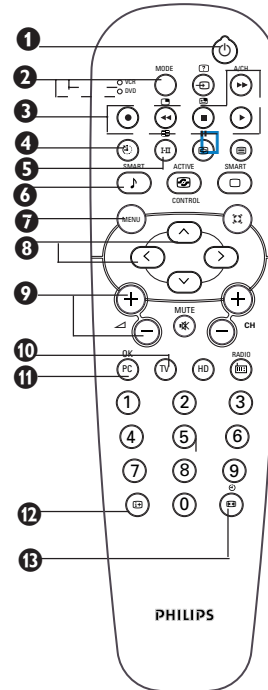



FUNCTIONS OF REMOTE CONTROL

14 AV / TELETEXT button

- In TV mode, it allows you to select the AV channels.
- In Teletext mode, it allows to access teletext information. (Refer to section on "Using the Teletext")

15 PICTURE-IN-PICTURE ON/OFF button

- When in PC mode, it allows you to call up a sub-screen within your main screen enabling you to watch a TV channel.

16 PICTURE-IN-PICTURE POSITION button

- When in PC mode, it allows you to position the sub-screen to be on the top left, top right, bottom right or the bottom left corner of your screen.

17 ALTERNATE CHANNEL button

Allows to alternate between the current channel and the previous channel.

18 TELETEXT / HOLD button

- In teletext mode, it allows you to access teletext information (Refer to section on "Using the Teletext").
- In VCR or DVD mode, it serves as a pause function for your VCR or DVD player.

19 TELETEXT button

Allows to access teletext mode.

20 SMART PICTURE button

Press the Smart Picture button repeatedly to access 5 different types of picture settings and choose your desired setting.

21 ACTIVE CONTROL button

Adjusts settings automatically for optimal picture quality under any signal conditions (Refer to section on "Using the Active Control")

22 SURROUND SOUND button

- Allows you to select Incredible Surround, Dolby Virtual Surround and Stereo sound when transmission is in stereo mode.
- Allows you to select Spatial Sound or Mono sound when transmission is in mono mode.

23 CURSOR RIGHT / DOWN buttons

- Cursor Right button allows you to access the sub-menus adjust the settings.
- Cursor Down button allows you to select the next item on the menu.

24 CHANNEL + / - buttons

Allows you to select channels in ascending or descending order.

25 MUTE button

Mutes sound. To restore sound, press button again.

26 RADIO button

Allows to access radio mode. (Refer to section on "Accessing the FM Radio Installation Menu")

27 HD (High Definition) button

Allows you to select the High definition mode when the "Y", "Pb and the "Pr" sockets at the HD INPUT at the rear of the LCD TV are connected to the to the "Y", "Pb" and "Pr" OUTPUT sockets of the DVD player.

28 DIGIT (0 -9) buttons

Allows you select a channel. **Note** : For a 2-digit number, the second digit must be entered before the "-" sign disappears.

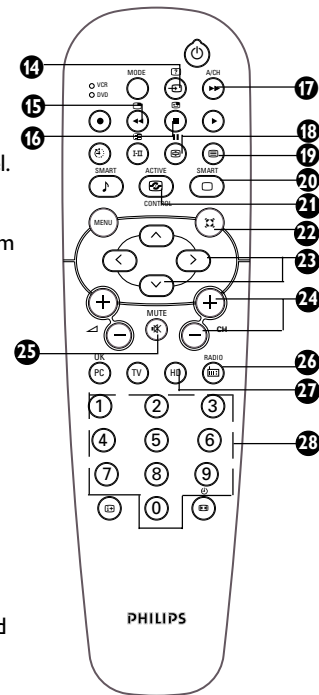



FUNCTIONS OF TV TOP CONTROLS

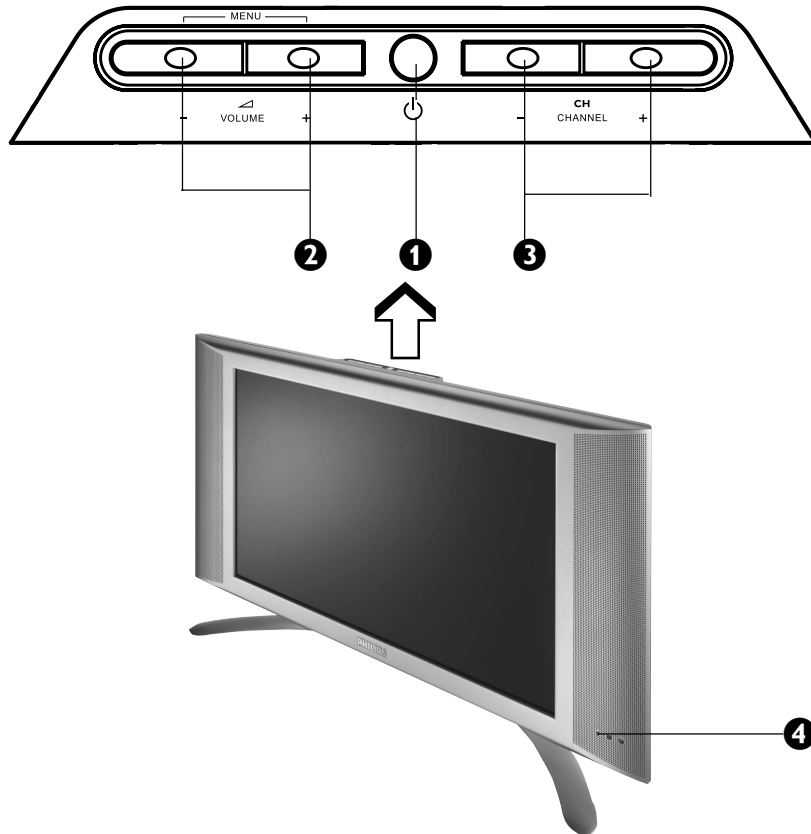

1	Mains Power button	Switch mains power on or off.
2	Volume - / + buttons	Adjust sound volume softer/louder.
3	Channel - / + buttons	Select channel in descending/ascending order.
4	Remote Sensor	Acts as a sensor for activating the controls of the TV when remote control handset is aimed at it.

Note

- You can enter the main menu by pressing both the Volume — and + buttons at the same time.
- Press the Channel + or — button to select the next item on the menu.
- Press Volume + or — button to access sub-menu and adjust the settings.





ACCESSING THE TV MAIN MENU AND SUB-MENUS

The TV main menu allows you to access to the **Picture**, **Sound**, **Features** and **Install** menus

How to call up the main menu

Press the (**MENU**) button to enter the main menu.

The 4 buttons , , and (**Cursor Up, Down, Left and Right**) on the remote control allow you to select the desired menu item, make adjustments and access the sub-menus. Use the (**OSD**) button to exit menu from screen.

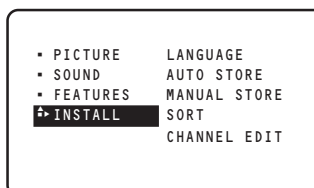

OVERVIEW OF TV MAIN MENU AND SUB-MENUS

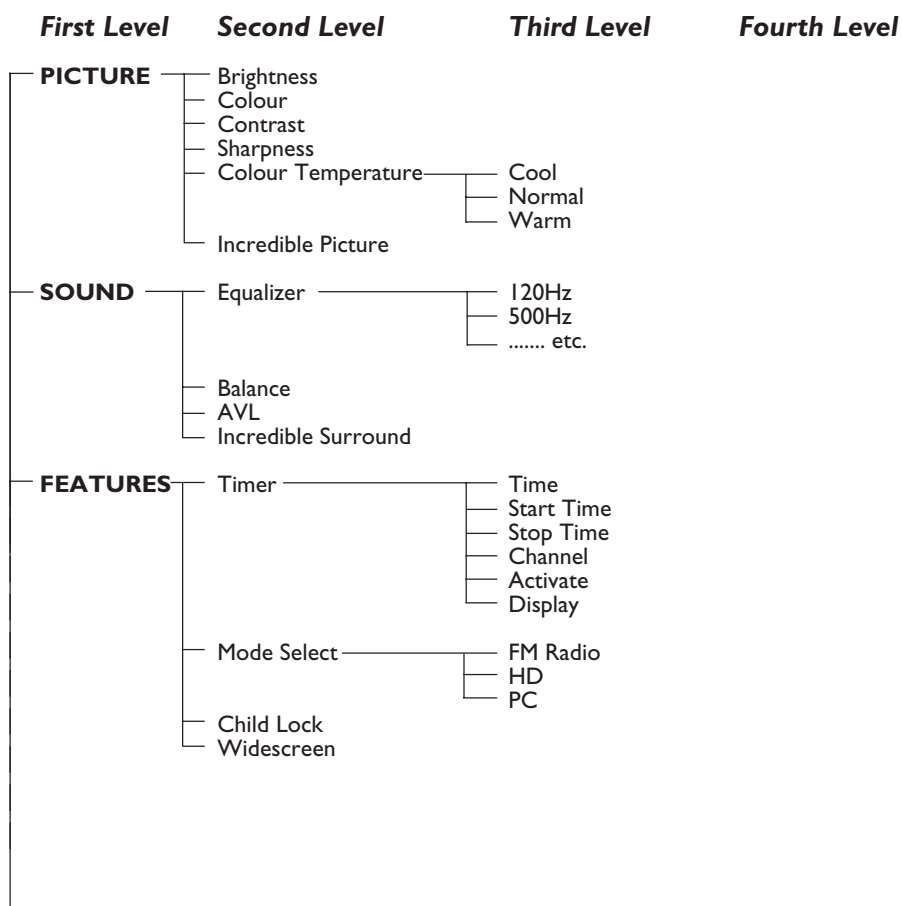



..... OVERVIEW OF TV MAIN MENU AND SUB-MENUS

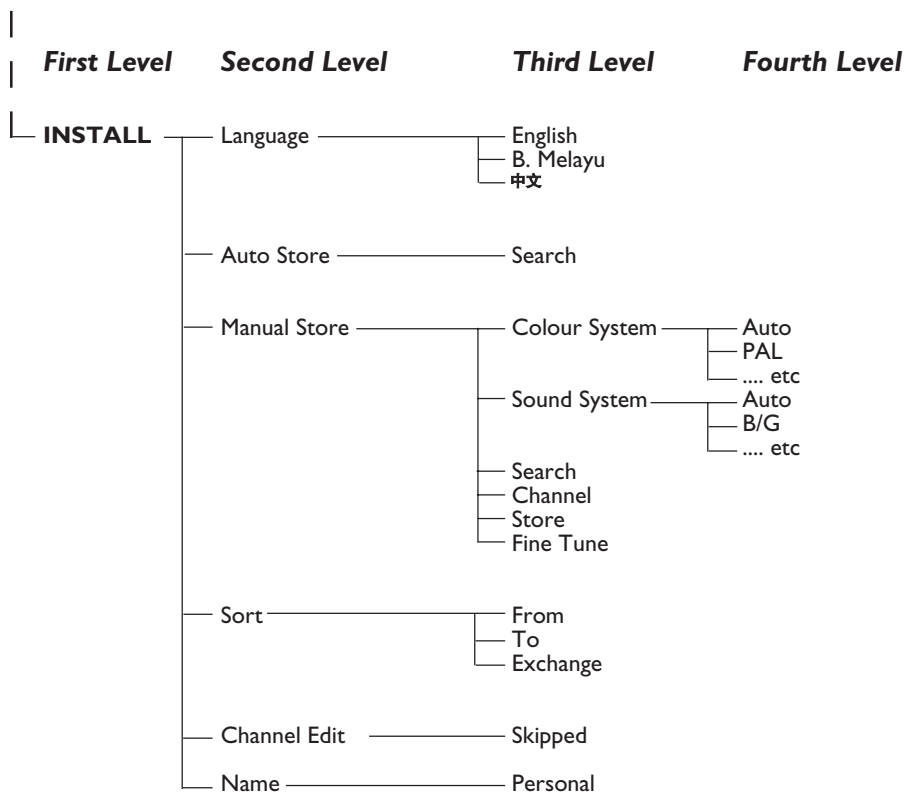



OVERVIEW OF FM RADIO MAIN MENU AND SUB-MENUS

This TV also provides you with the **FM RADIO** for your listening pleasure. To enable you to access the **FM RADIO** mode, you must connect the cable from FM Rntenna socket to the FM Radio mains. Press  (**FM RADIO**) button to enter into FM Radio mode.

Here is an overview of the FM RADIO Main menu and Sub-menus

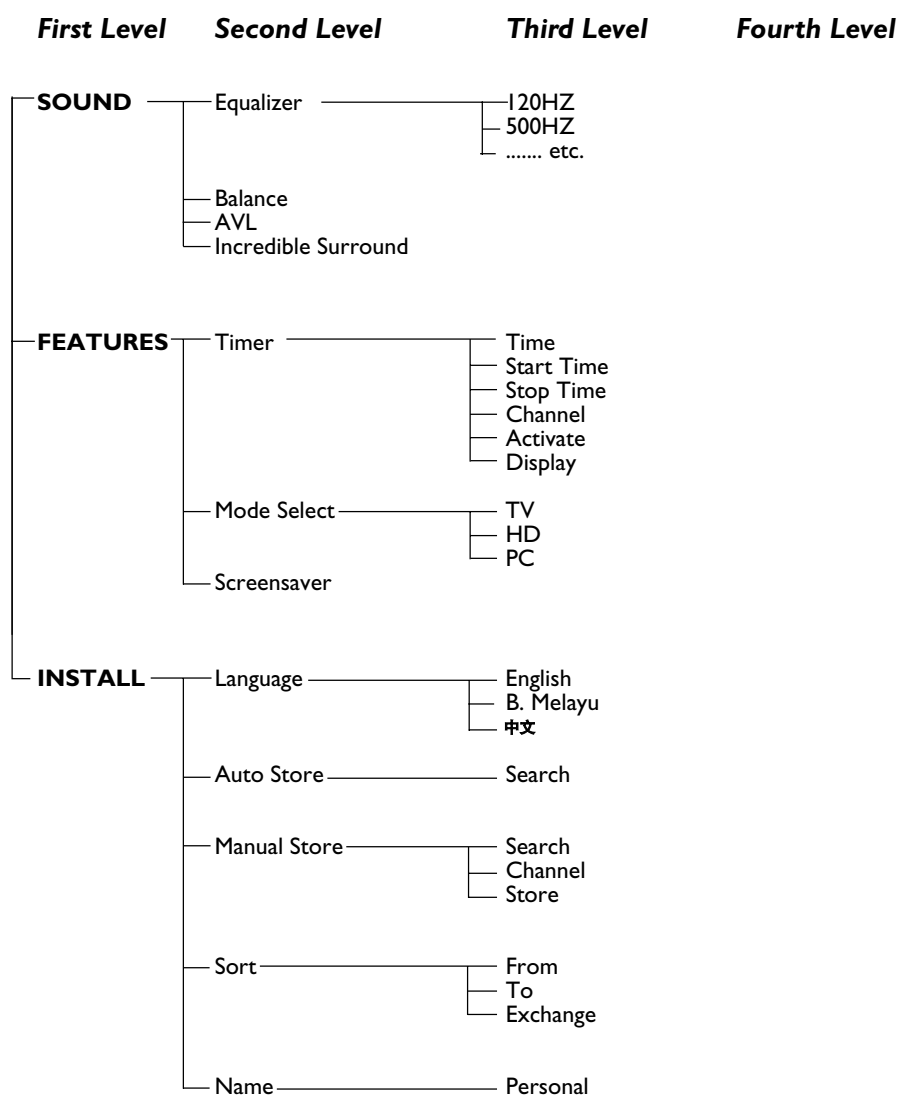



OVERVIEW OF PC MENU AND SUB-MENUS

This TV also allows you use your TV as a PC monitor. To enable you to access PC mode in the TV, you must connect the following :-

- 1 Connect DC input terminal to the AC adaptor.
- 2 Connect the Mains Plug from the AC adaptor to the AC outlet.
- 3 Connect the PC input (VGA) to the Monitor Output of your PC.
- 4 Connect Audio L and R output of your PC to the Audio in (PC) L and R of your TV.
- 5 Press **PC** button to enter into PC mode.
- 6 Press **MENU** button to enter into the PC Main Controls Menu.

First Level

Second Level

Third Level

Fourth Level

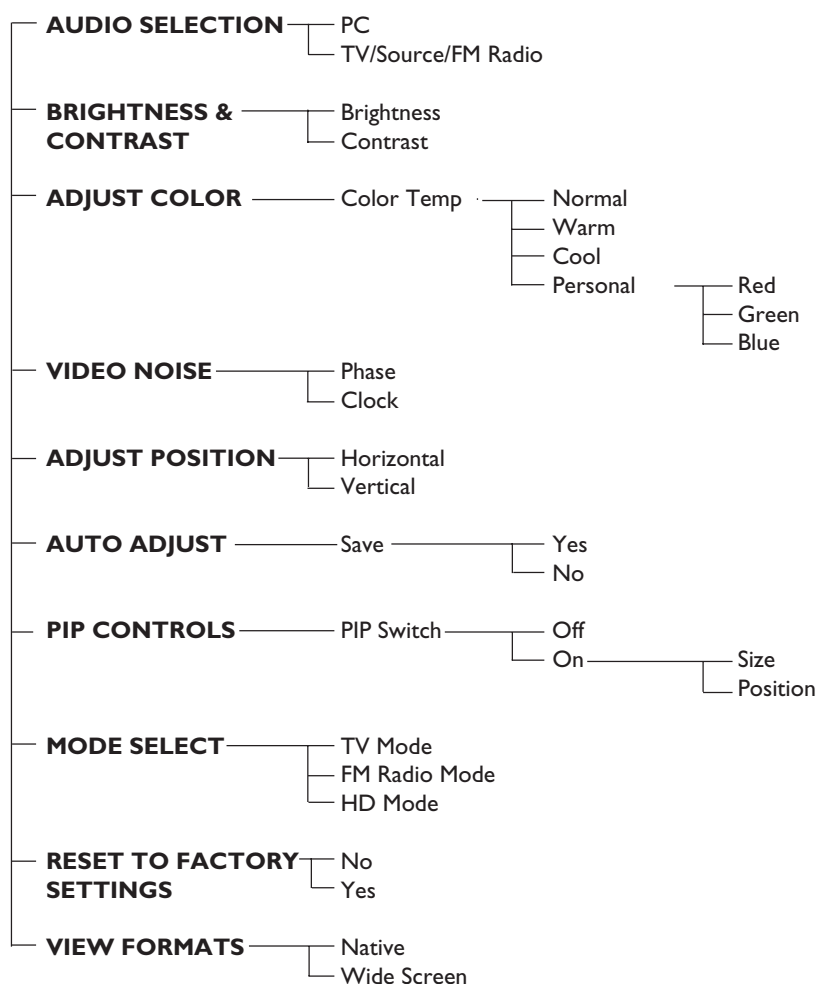



OVERVIEW OF HD MENU AND SUB-MENUS

The HD (High Definition) mode offers you Picture and Sound adjustments, Mode Select and Lock Channel feature.

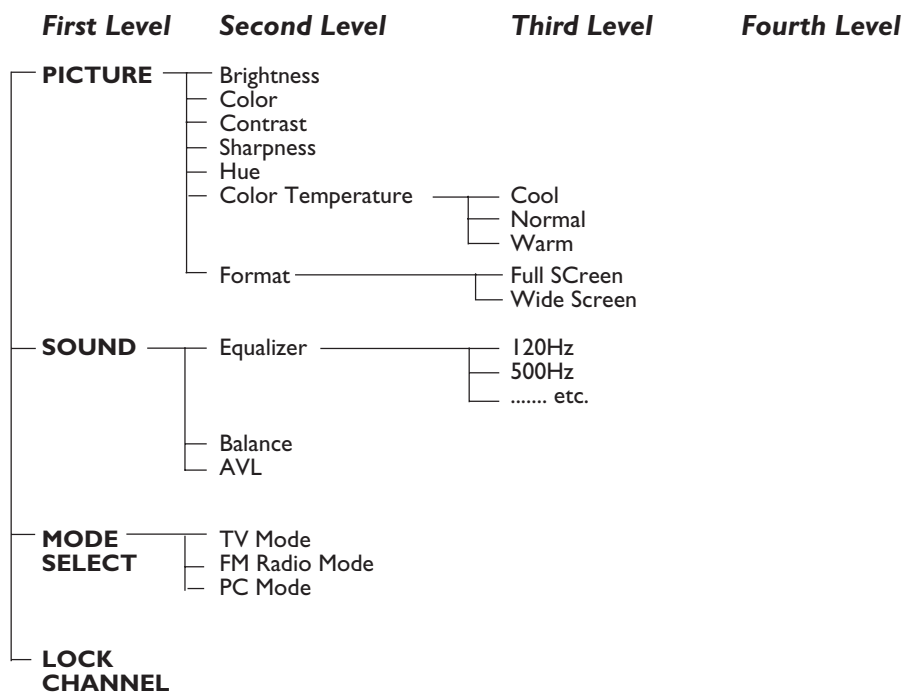



ACCESSING THE LCD TV INSTALLATION MENU

Before you access the TV installation menu, ensure you are in TV mode. If you are not in TV mode, press the (TV) button on the remote control to enter into TV mode.

INSTALL ▲

◀ LANGUAGE ▶▶ ENGLISH

▪ AUTO STORE B.MELAYU

▪ MANUAL STORE 中文

▪ SORT

▪ CHANNEL EDIT

▪ ▼

1. Enter main menu. 2. Select **INSTALL**. 3. Enter Install menu.

CHOOSING THE MENU LANGUAGE AND AUTOMATIC TUNING OF LCD TV CHANNELS

The Language menu allows you to set the TV's on-screen menu to be shown in your desired language.

Press Button

- 4. Enter **LANGUAGE** mode.
- or 5. Select desired language.
- 6. Exit **LANGUAGE** mode.
- 7. Select **AUTO STORE**.
- 8. Start automatic tuning.
- 9. When automatic tuning of channels is completed, exit menu from screen.

Result on Screen

INSTALL ▲

◀ LANGUAGE ▶▶ ENGLISH

▪ AUTO STORE B.MELAYU

▪ MANUAL STORE 中文

▪ SORT

▪ CHANNEL EDIT

▪ ▼

INSTALL ▲

◀ LANGUAGE ▶

◀ AUTO STORE ▶▶ SEARCH

▪ MANUAL STORE

▪ SORT

▪ CHANNEL EDIT

▪ ▼

INSTALL ▲

▪ LANGUAGE ▶

▪ AUTO STORE ▶▶ SEARCHING

◀ MANUAL STORE PLEASE WAIT

▪ SORT CHANNEL FOUND 8

▪ CHANNEL EDIT 048.31 MHZ

▪ ▼



ACCESSING THE LCD TV INSTALLATION MENU

MANUAL TUNING OF LCD TV CHANNELS

Manual tuning allows you to store each programmes manually.

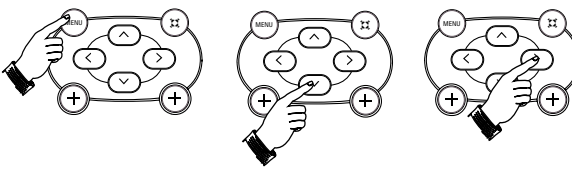

INSTALL

- ◀ LANGUAGE ▶ ENGLISH
- AUTO STORE B.MELAYU
- MANUAL STORE 中文
- SORT
- CHANNEL EDIT
-

1. Enter main menu. 2. Select **INSTALL**. 3. Enter Install menu.

Press Button

Result on Screen

4. Press button repeatedly until **MANUAL STORE** is selected.
5. Enter **MANUAL STORE** menu.
6. Select **SEARCH**.
7. Start manual tuning. Searching stops once a transmitting channel is found.
8. Select **CHANNEL**.
9. Key in the desired channel number.
10. Select **STORE**.
11. Store tuned channel.
12. Exit menu from screen.





ACCESSING THE LCD TV INSTALLATION MENU

SELECTING THE COLOUR/SOUND SYSTEM

This feature allows you to select your desired **COLOUR** and **SOUND** system. If **AUTO** is selected, the respective colour and sound system will be automatically selected according to the transmission system. **Note** : Select your desired colour and sound system manually if reception is poor at **AUTO** mode. If the colour system is selected manually, that is, **AUTO** is not selected, the sound system selected should also not be **AUTO** and vice versa.

Press Button

Result on Screen

Repeat step 1 to step 5 as in “**MANUAL TUNING OF CHANNELS**”

6. **COLOUR SYSTEM** is selected.
Enter **COLOUR SYSTEM** mode.
7. Select the desired colour system.
8. Exit from colour system mode.
9. Proceed to select the **SOUND SYSTEM**.
10. Enter **SOUND SYSTEM** mode.
11. Select the desired sound system.
12. Exit from sound system mode.
13. Press button repeatedly until **STORE** is selected.
14. Store selected system.
15. Exit menu from screen.

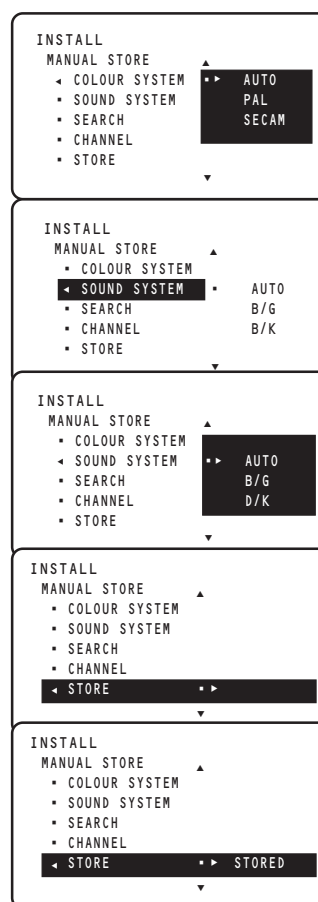



ACCESSING THE LCD TV INSTALLATION MENU

FINE TUNING OF LCD TV CHANNELS

This feature allows you to adjust picture reception in areas of weak reception.

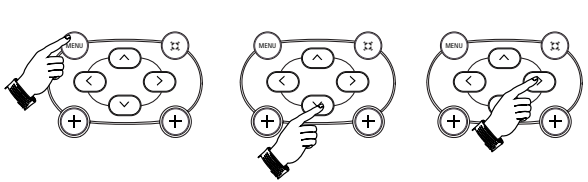

INSTALL

- ◀ LANGUAGE ▶▶ ENGLISH
- AUTO STORE B. MELAYU
- MANUAL STORE 中文
- SORT
- CHANNEL EDIT
-

1. Enter main menu. 2. Select **INSTALL**. 3. Enter Install menu.

Press Button

Result on Screen

4. Press button repeatedly until **MANUAL STORE** is selected.
5. Enter **MANUAL STORE** menu.
6. Press button repeatedly until **FINE TUNE** is selected.
7. Start fine-tuning until desired picture and sound is obtained.
8. Select **Store**.
9. Store last fine-tuned status.
10. Exit menu from screen.

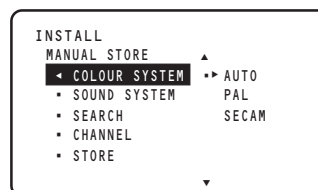



ACCESSING THE LCD TV INSTALLATION MENU

SORTING OF LCD TV CHANNELS

This menu allows you to change channel number of your choice for a particular station.

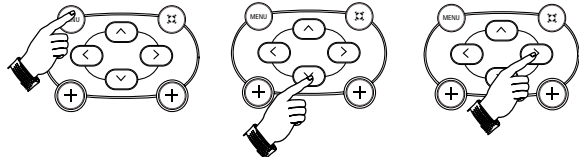

```

INSTALL
< LANGUAGE      >> ENGLISH
  < AUTO STORE   >> B.MELAYU
  < MANUAL STORE >> 中文
  < SORT
  < CHANNEL EDIT
  <
    
```

1. Enter main menu. 2. Select **INSTALL**. 3. Enter Install menu.

Press Button



4. Press button repeatedly until **SORT** is selected.



5. Enter **SORT** menu.



6. Key in the channel number in the **FROM** column, that is the channel you want to swap from.



7. Select **TO**.



8. Key in the channel number in the **TO** column, that is, the channel you want to swap to.



9. Select **EXCHANGE**.



10. Activate exchange of channels.



11. Exit menu from screen.

Result on Screen

```

INSTALL
  < LANGUAGE      >> FROM
  < AUTO STORE    >> TO
  < MANUAL STORE  >> EXCHANGE
  < SORT
  < CHANNEL EDIT
  <
    
```

```

INSTALL
SORT
  < FROM      >> 8
  < TO
  < EXCHANGE
  <
    
```

```

INSTALL
SORT
  < FROM
  < TO      >> 6
  < EXCHANGE
  <
    
```

```

INSTALL
SORT
  < FROM
  < TO
  < EXCHANGE >> EXCHANGED
  <
    
```



ACCESSING THE LCD TV INSTALLATION MENU

EDITING OF LCD TV CHANNELS

This feature allows you to edit or skip channels which have bad or weak TV signal or channels that you do not watch often.

Note : Once a channel is skipped, you cannot have access to it by the **CHANNEL +** or **-** button. You can only access the channel by the **DIGIT (0 -9)** button.

INSTALL

- ◀ LANGUAGE ▶ ENGLISH
- AUTO STORE B.MELAYU
- MANUAL STORE 中文
- SORT
- CHANNEL EDIT
-

1. Enter main menu. 2. Select **INSTALL**. 3. Enter Install menu.

Press Button

Result on Screen

4. Press button repeatedly until **CHANNEL EDIT** is selected.
5. Enter channel edit mode.
6. Select the channel you want to skip.
7. Activate skipped mode.
8. Exit menu from screen.

INSTALL

- LANGUAGE 3
- AUTO STORE 4
- MANUAL STORE 5
- SORT 6
- ◀ CHANNEL EDIT ▶ 7

INSTALL

- LANGUAGE 3
- AUTO STORE 4
- MANUAL STORE 5
- SORT 6
- ◀ CHANNEL EDIT ▶ 7

INSTALL

- LANGUAGE 3
- AUTO STORE 4
- MANUAL STORE 5
- SORT 6
- ◀ CHANNEL EDIT ▶ 7 SKIPPED

How to add back channels

- Repeat steps 1 to 5 as in “Editing of Channels”.
- Select the channel you want to add back by the **▲ (CURSOR UP)** or **▼ (CURSOR DOWN)** button.
- Press the **➤ (CURSOR RIGHT)** button to activate adding back of channel.
- Exit menu from screen by the **⏻ (OSD)** button.

ACCESSING THE LCD TV INSTALLATION MENU

NAMING OF LCD TV CHANNELS

This feature allows you to enter a new name or modify an existing name of a channel for 40 programmes (from 1 to 40) including external channels.

1. Enter main menu. 2. Select **INSTALL**. 3. Enter Install menu.

Press Button

4. Press button repeatedly until **NAME** is highlighted.
5. Enter **NAME** mode.
6. Select desired preset name and press **>** (**CURSOR RIGHT**) button to store selected pre-set name.
7. If you select **PERSONAL**, move to first character slot
8. Press button repeatedly to cycle through the characters and select desired character. Move to next character slot by the **>** (**CURSOR RIGHT**) button and key in the next character. (You can enter up to a maximum of 5 characters)
9. Store named channel.
10. Exit menu from screen.

Result on Screen



USING THE LCD TV PICTURE/SOUND MENU

The picture and sound menus allow you to make adjustments to the picture and sound. It also allow you to select and activate other features in the menu.

1. Press the (MENU) button to enter main menu.
2. Use the (CURSOR UP/DOWN) buttons to select the items on the PICTURE/SOUND menu.
3. Use the (CURSOR LEFT/RIGHT) buttons to access the sub-menus.

Picture menu items	Activities
Brightness	Increase or decrease brightness level.
Colour	Increase or decrease color level.
Contrast	Increase or decrease contrast level until lightest parts of the picture show good detail.
Sharpness	Increase or decrease sharpness level to improve detail in the picture.
Colour Temp	Allows you a choice of 3 picture settings (NORMAL, WARM and COOL).
Incredible Picture	Select "ON" to allow you to optimise the total contrast for improved picture quality.

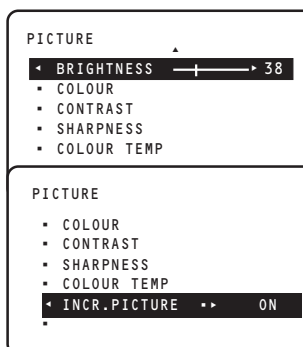

Note : HUE feature is only applicable to NTSC programmes. The HUE item will not appear on the menu if programme is in PAL mode.

Sound menu items	Activities
Equalizer	Allows you a choice of different sound frequencies.
BALANCE	Increase or decrease to adjust balance level.
AVL (Auto Volume Leveller)	As variation in signal conditions can result a sudden change in volume during in commercial breaks or channel switching, selecting the "ON" function will enable the volume to remain at a standard volume level.
Incredible Surround	Allows you to select between Stereo, Dolby Virtual and Incredible Surround sound. when transmission is in stereo. Allows you to select between Spatial and Mono sound when transmission is in mono.

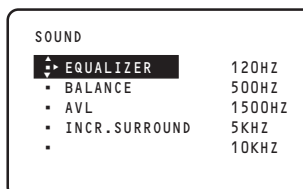



ACCESSING THE LCD TV FEATURES MENU

ACTIVATING THE TIMER

The Timer feature allows you to set the timer to switch to another channel at a specified time while you are watching another channel or when the TV is on standby mode.

Note : For the timer to function, the set must not be switched off. Once the set is switched off, the timer is disabled.

FEATURES	
⇄ TIMER	TIME
• MODE SELECT	START TIME
• CHILD LOCK	STOP TIME
• WIDE SCREEN	CHANNEL
	ACTIVATE

1. Enter main menu. 2. Select **FEATURES**. 3. Enter **FEATURES** menu.

Press Button

4. Enter the **TIMER** menu.
5. Enter **TIME** mode.
6. Key in the current time For example, if the current time is 12:30, key digit 1 and 2 in the hour column, followed by digit 3 and 0 in the minute column.
7. Exit from **TIME** mode.
8. Select **START TIME**.
9. Enter the **START TIME** mode.
10. Key in the time you want the programme to be switched on.
11. Exit from **START TIME** mode.
12. Select **STOP TIME**.

Result on TV Screen

SCREEN 1: FEATURES menu with **TIMER** selected.

SCREEN 2: **TIME** mode with 12:30 entered.

SCREEN 3: **START TIME** mode with 13:30 entered.

SCREEN 4: **STOP TIME** mode with ---:-- entered.

ACCESSING THE LCD TV FEATURES MENU

..... ACTIVATING THE TIMER

Press Button

13. Enter **STOP TIME** mode.
14. Key in the time you want the programme to be switched off.
15. Exit from **STOP TIME** mode.
16. Select **CHANNEL**.
17. Key in the channel you want to switch to.
18. Select **ACTIVATE**.
19. Activate timer. You can select to activate timer by **DAILY** or **ONCE** mode.
20. Select **DISPLAY**.
21. Select **ON** mode if you want to display the current time on the TV screen.
22. Exit menu from screen.

Result on TV Screen

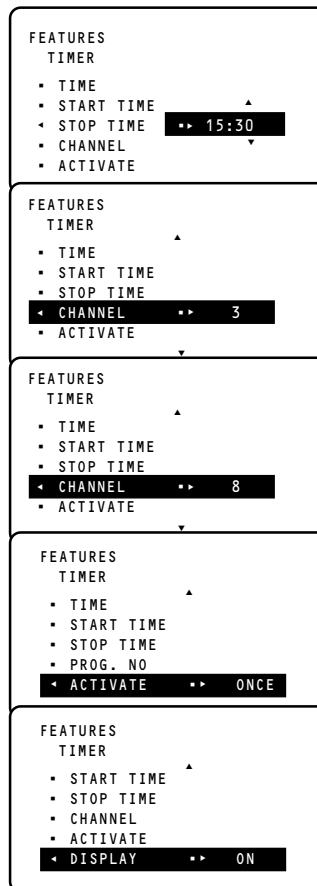

Note

30 seconds before the timer is activated, a message indicating the time left for the channel switch will appear on the screen. To disable the channel switch, press any button on the remote control.



ACCESSING THE LCD TV FEATURES MENU

USING THE MODE SELECT

This menu allows you to go into **FM RADIO**, **HD** or **PC** mode.

1. Enter main menu. 2. Select **FEATURES**. 3. Enter **FEATURES** menu.

FEATURES	
• TIMER	TIME
• MODE SELECT	START TIME
• CHILD LOCK	STOP TIME
• WIDE SCREEN	CHANNEL
	ACTIVATE

Press Button



4. Select **MODE SELECT**.



5. Enter **MODE SELECT** menu.

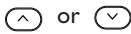

6. Select your desired mode.



7. Enter selected mode.

Result on TV Screen

FEATURES	
• MODE SELECT	FM RADIO
• CHILD LOCK	HD
• WIDE SCREEN	PC

FEATURES	
MODE SELECT	
• FM RADIO	
• HD	
• PC	

Note : You can also access directly the **FM RADIO**, **HD** and **PC** modes by the   and  buttons.



ACCESSING THE LCD TV FEATURES MENU

ACTIVATING THE CHILD LOCK (ACCESS CODE)

The Child Lock feature allows you to lock channels on your TV Top Controls to prevent your children from watching programmes you deem undesirable.

Note : You cannot have access to the locked channels via the top controls of the TV set once the channels are locked. You can only have access to the locked channels via the remote control. Keep the remote control out of reach so as to prevent your children from having access to it.

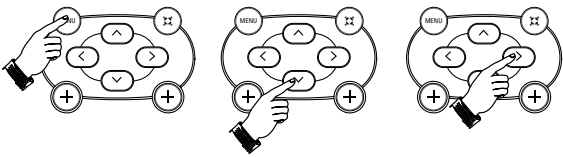

FEATURES

- TIMER
- MODE SELECT
- CHILD LOCK
- WIDE SCREEN

TIME
START TIME
STOP TIME
CHANNEL
ACTIVATE

1. Enter main menu. 2. Select **FEATURES**. 3. Enter **FEATURES** menu.

Press Button



4. Select **CHILD LOCK**.



5. Enter **ACCESS CODE** mode.



6. Key in access code **0711** (0711 is the default access code). A message **INCORRECT** will appear.



7. Key in **0711** the second time. When the message **CORRECT** appears, the **CHILD LOCK** menu is now accessible.

You can now proceed to change the access code of your choice.

Result on TV Screen

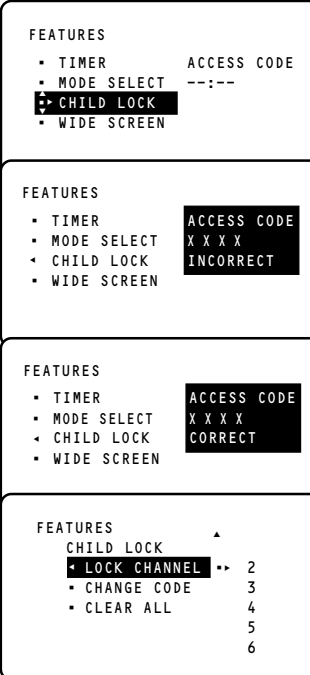

FEATURES

- TIMER
- MODE SELECT
- **CHILD LOCK**
- WIDE SCREEN

ACCESS CODE
--:--

FEATURES

- TIMER
- MODE SELECT
- CHILD LOCK
- WIDE SCREEN

ACCESS CODE
X X X X
INCORRECT

FEATURES

- TIMER
- MODE SELECT
- CHILD LOCK
- WIDE SCREEN

ACCESS CODE
X X X X
CORRECT

FEATURES

CHILD LOCK

- **LOCK CHANNEL**
- CHANGE CODE
- CLEAR ALL

2
3
4
5
6



ACCESSING THE LCD TV FEATURES MENU

ACTIVATING THE CHILD LOCK (CHANGE CODE)

Press Button



8. Select **CHANGE CODE**.



9. Enter **CHANGE CODE** mode.



10. Key in the access code of your choice.



11. Confirm access code.

When the new code is confirmed, the message **CORRECT** will appear.



12. Exit menu from screen.

Result on TV Screen

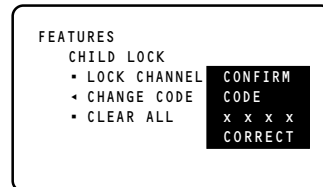
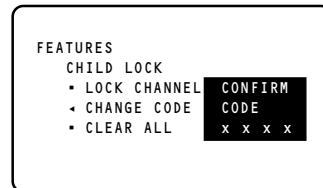

Note : After you have exit menu from screen and you want to enter child lock menu again , you need to key the new access code only once. If you have forgotten the new access code, key in 0711 twice to enter the child lock menu. Upon entering the child lock menu, you can proceed to change code again.



ACCESSING THE LCD TV FEATURES MENU

ACTIVATING THE CHILD LOCK (LOCK CHANNEL)

FEATURES

- ▣ **TIMER** TIME
- ▣ MODE SELECT START TIME
- ▣ **CHILD LOCK** STOP TIME
- ▣ WIDE SCREEN CHANNEL
- ACTIVATE

1. Enter main menu. 2. Select **FEATURES**. 3. Enter **FEATURES** menu.

Press Button

- 4. Select **CHILD LOCK** .
- 5. Enter **ACCESS CODE** mode.
- 6. Key in access code .
- 7. Enter **LOCK CHANNEL** mode.
- or 8. Select the channel you want to block.
- 9. Activate blocking of channel. A keylock symbol will appear beside the channel number indicating that it is locked.
- 10. Exit menu from screen.

Result on TV Screen

FEATURES

- ▣ **TIMER** ACCESS CODE
- ▣ MODE SELECT --- --
- ▣ **CHILD LOCK** --- --
- ▣ WIDE SCREEN

FEATURES

- ▣ **TIMER** ACCESS CODE
- ▣ MODE SELECT X X X X
- ▣ **CHILD LOCK** CORRECT
- ▣ WIDE SCREEN

FEATURES

CHILD LOCK

- ▣ **LOCK CHANNEL** 2
- ▣ CHANGE CODE 3
- ▣ CLEAR ALL 4
- 5
- 7

FEATURES

CHILD LOCK

- ▣ **LOCK CHANNEL** 3
- ▣ CHANGE CODE 4
- ▣ CLEAR ALL 5
- 6
- 7

Note : You cannot have access to the locked channels via the top controls of the TV set. You can only have access to the locked channels via the remote control. When AVI source is locked, CVI source is automatically locked. Like-wise, if CVI source is locked, AVI source is also automatically locked as they share the same audio input.

If you attempt to enter the **INSTALL** menu after locking a channel, a message "Enter **ACCESS CODE**" will appear on the screen. You need to enter the **ACCESS CODE** to enable you to enter the **INSTALL** menu.





ACCESSING THE LCD TV FEATURES MENU

ACTIVATING THE CHILD LOCK (CLEAR ALL)

To unlock channels that you have locked, enter the Child Lock menu and activate the **CLEAR ALL** mode.

FEATURES

- TIMER
- MODE SELECT
- CHILD LOCK
- WIDE SCREEN

TIME
START TIME
STOP TIME
CHANNEL
ACTIVATE

1. Enter main menu. 2. Select **FEATURES**. 3. Enter **FEATURES** menu.

Press Button

4. Select **CHILD LOCK**.
5. Enter **ACCESS CODE** mode.
6. Key in access code.
7. Press button repeatedly until **CLEAR ALL** is selected.
8. Activate clearing of all locked channels.
9. Exit menu from screen.

Result on TV Screen

FEATURES

- TIMER
- MODE SELECT
- **CHILD LOCK**
- WIDE SCREEN

ACCESS CODE
--:--

FEATURES

- TIMER
- MODE SELECT
- CHILD LOCK
- WIDE SCREEN

ACCESS CODE
X X X X
CORRECT

FEATURES

- CHILD LOCK
- LOCK CHANNEL
- CHANGE CODE
- **CLEAR ALL**

FEATURES

- CHILD LOCK
- LOCK CHANNEL
- CHANGE CODE
- **CLEAR ALL**

**CLEARED

Note



You can also unlock individual channel by the **LOCK CHANNEL** menu

- Repeat **step 1 to 7** as in “**ACTIVATING THE CHILD LOCK (LOCK CHANNEL)**”.
- Select the channel you want to unlock by the or (**CURSOR UP / DOWN**) buttons.
- Press the (**CURSOR RIGHT**) button to unlock channel (the keylock symbol will disappear).



USING THE SCREEN FORMAT

Screen Format function allows you a choice of different formats for your viewing pleasure, namely : - **4:3**, **Zoom 14:9**, **Zoom 16:9**, **Subtitle Zoom**, **Superwide**, **Widescreen** and **Full Screen**.

Enter the **FEATURES** menu and select **WIDE SCREEN** to cycle through the various screen formats and select the format of your choice. You can also use  (**SCREEN FORMAT**) or   buttons to cycle through the various screen formats.

Definition of Screen Formats

4:3 Mode

This picture is reproduced in 4:3 format and a black band is displayed on either side of the picture.

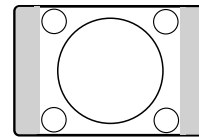

Zoom 14:9 Mode

This picture is enlarged to 14:9 format, a thin black band remains on both sides of the picture.

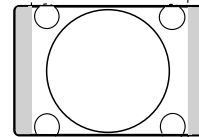

Zoom 16:9 Mode

This picture is enlarged to 16:9 format. This mode is recommended when displaying pictures which have black bands at the top and bottom (letterbox format).

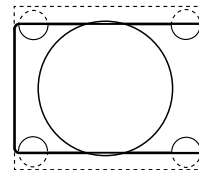

Subtitle Zoom Mode

This mode is use to display 4:3 pictures using the full surface of the screen leaving the subtitles visible.

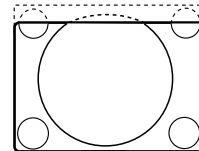

Superwide Mode

This mode is use to display 4:3 pictures using the full surface of the screen by enlarging the sides of the picture.

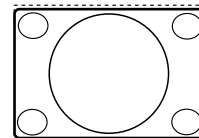

Widescreen Mode

This mode restores the correct proportions of pictures transmitted in 16:9 using full screen display.

Note : If you display a 4:3 picture in this mode, it will be enlarged horizontally.

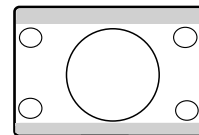

Full Screen

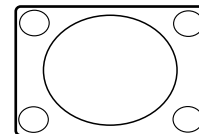

Select this mode when displaying pictures have black bands at the top and bottom or at the left and right to enable you to enjoy full display of the picture on the screen.





ACTIVATING THE SLEEPTIMER

Sleeptimer function allows you to select a time period in which the set will switch to standby mode automatically upon reaching the selected time period. You have a choice of time period starting from **OFF** up to a maximum of 240 minutes

1. Press the  (**SLEEPTIMER**) button to display the time period.
2. Press the  (**SLEEPTIMER**) button repeatedly to cycle through the various time periods and select the time period of your choice.

Note

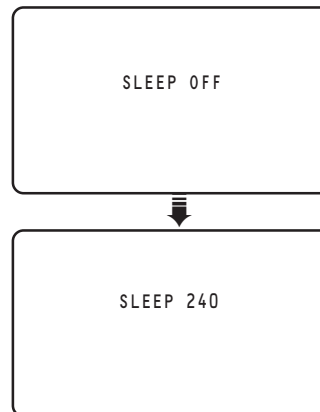

- During the last minute of a Sleep time setting, an on-screen countdown will be displayed. Pressing any button on the remote control during the countdown will cancel the Sleep-timer.
- During the last 10 seconds of a Sleep timer setting, an on-screen display will read Goodbye.



ACTIVATING THE ACTIVE CONTROL

This feature automatically adjust settings for optimal picture quality continuously under any signal conditions. You have a choice of 4 modes : **ACTIVE CONTROL OFF**, **ACTIVE CONTROL MIN**, **ACTIVE CONTROL MED** and **ACTIVE CONTROL MAX**

HOW TO ACCESS AND SELECT THE ACTIVE CONTROL MODE

1. Press the  (**ACTIVE CONTROL**) button repeatedly to cycle through the various four **ACTIVE CONTROL** modes and select your desired mode.
2. Press  (**OSD**) button to exit menu from screen or wait for the On-Screen Display to time out.

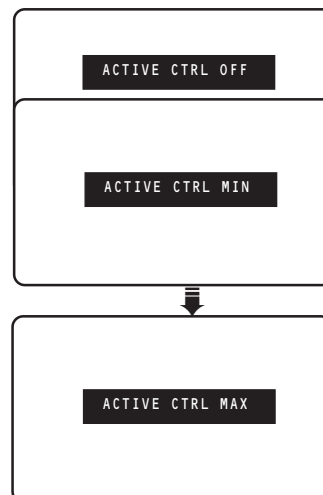



ACTIVATING THE LCD TV SMART PICTURE / SOUND CONTROL

SMART PICTURE feature offers you a choice of 5 picture settings, namely, **RICH**, **NATURAL**, **SOFT**, **PERSONAL** and **MULTIMEDIA**.

SMART SOUND feature offers you a choice of 4 sound settings, namely, **THEATRE**, **MUSIC**, **VOICE** and **PERSONAL**.

Press  (**SMART PICTURE**) or  (**SMART SOUND**) button repeatedly to cycle through the settings to select your desired mode.

Definition of Picture Settings

- PERSONAL** : Picture settings are set to your preference.
- RICH** : Emphasize very vibrant colours. (Suitable for AV mode in brightly-lit room)
- NATURAL** : Emphasize original colours.
- SOFT** : Emphasize "warm" colours. (Suitable for dimly-lit room condition and gives cinema-like effect when light is switched off).
- MULTIMEDIA** : Emphasize "soft" colours. (Suitable for playing computer games, surfing, etc.)

Note : The **PERSONAL** setting is the setting that you set up using the Picture menu in the main menu. This is the only setting in the Smart Picture settings that can be changed. All the other settings are pre-set at the factory.

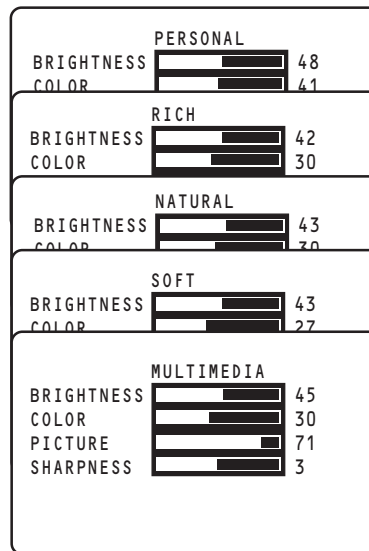

Definition of Sound Settings

- PERSONAL** : Sound settings are set to your preference.
- VOICE** : Emphasize high tone. (Treble boosted)
- MUSIC** : Emphasize low tone. (Bass boosted)
- THEATRE** : Emphasize sensation to action. (Bass and Treble boosted)

Note : The values shown in the Picture/Sound Setting diagrams are sample values only. Your television's values may vary and display different numbers.

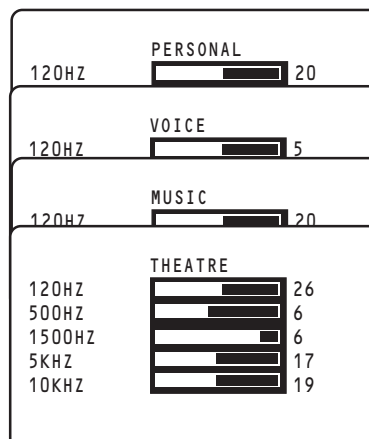



USING THE TELETEXT

If a TV channel broadcast contains teletext information, each channel that broadcasts teletext transmits a page (index page) with information on how to use the teletext system, usually on page 100. The system transmitted is indicated in the option line at the bottom of the screen.

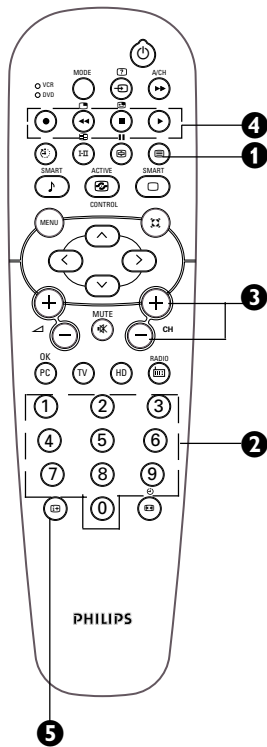

1 On/Off teletext and Superimpose teletext page over TV programme

Press the button once to switch on teletext display. (A channel in which teletext is being transmitted must be selected). Press the button the second time superimpose the teletext page over the TV programme. Press the button the third time to exit teletext mode.



2 Selecting a teletext page

Key in the required teletext page (3 digits). The page number is displayed at the top left hand corner of the screen. When the teletext page is located, the counter stops searching. If the counter keeps searching, it means that the page is not available for selection. If you make a mistake in keying the page number, you have to complete keying the 3-digit number before re-keying the correct page number.



3 Accessing a teletext page

Press the **CHANNEL +** button to display the next page and the **CHANNEL -** button to display the previous page.



4 Direct Access to an item or corresponding pages

The 4-colour buttons allow you to access directly an item or corresponding pages.



5 Main Index

Press the button to return to the main index page.





USING THE TELETEXT

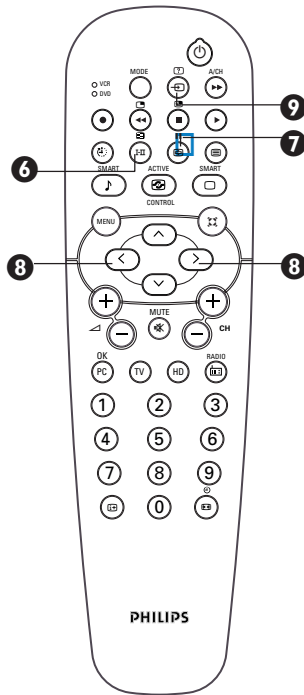

6 Dual Page Text

Press button to enable you to display dual page text.



7 Hold

When a dual page is displayed, use this button to toggle between the dual page. Once an active page is selected, the other page will be on hold mode. If the page has sub-pages, use the **Cursor Right** or **Left** button to access the next or previous page



8 Selecting a sub-page

For a teletext page with sub-pages, press the **Cursor Left** or **Right** button to access the previous sub-page or the next subpage.



9 Reveal/Conceal

Press the button once to reveal hidden information (solutions to puzzles, riddles, etc). Press the button the second time to conceal information. This button is applicable only to teletext page with puzzles, riddles, etc.)



How to select your favourite page

This feature allows you select 4 of your favourite or most commonly viewed page and stored them in the favourite page selection. You can then access directly your favourite page by the colour buttons without having to key in the page number.







1. Press the (**TELEXTEXT ON/OFF**) button to enter teletext mode.
2. Press the (**MENU**) button to enter favourite page selection. **Note** : The colour alphabets at the bottom of the screen is now changed to page numbers.
3. Key in your favourite page by the (**DIGIT 0 -9**) buttons.
4. Press the (**OSD**) button followed by your desired colour button to store your favourite page.
5. Repeat **step 3** to **4** to select and store other favourite pages.
6. To exit Favourite page mode, press (**MENU**) button.
7. Press the (**TELEXTEXT ON/OFF**) button twice to exit teletext mode.



ACCESSING THE FM RADIO INSTALLATION MENU

This TV also provides you with the **FM RADIO** for your listening pleasure. To enable you to access the **FM RADIO** mode, you must connect the cable from FM Antenna socket to the FM Radio mains.

Press Button

1. Enter into FM Radio mode. 
2. Enter **FM RADIO** main menu. 
3. Press button button repeatedly until **INSTALL** is highlighted. 
4. Enter **INSTALL** menu. 
5. Press button button repeatedly to scroll through the available FM Mode On-screen options. These options include **LANGUAGE, AUTO STORE, MANUAL STORE, SORT** and **NAME**.
 - LANGUAGE** – Choose to view the On-screen menu in your desired language.
 - AUTO STORE** – Allows you to search the FM antenna signal and store any FM channel it finds in the TV's memory.
 - MANUAL STORE** – Allows you to manually tune any available FM signals.
 - SORT** – Allows you to rearrange your stored FM stations in the order you prefer.
 - NAME** – Allows you to apply a name to your programmed FM radio stations. Add your own personal name or choose one from the predefined list.
6. Adjust or select items within the highlighted feature sub-menu. 
7. Exit menu from screen. 

Result on TV Screen

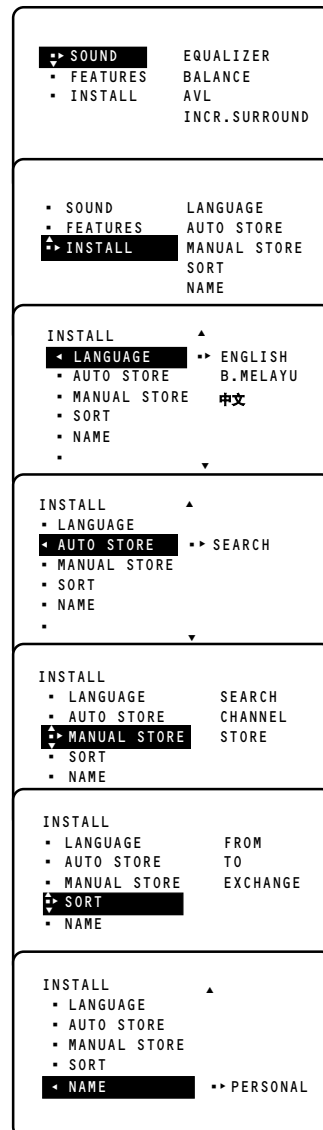



USING THE FM RADIO SOUND MENU

The Sound menu allows you to make adjustments to the sound.

Note: Ensure you are in **FM RADIO** mode before you access **FM RADIO** main menu.

1. Press button to enter **FM RADIO** main menu. **SOUND** option is highlighted.

2. Press button to enter the **SOUND** menu.

SOUND

- EQUALIZER 120HZ
- BALANCE 500HZ
- AVL 1500HZ
- INCR. SURROUND 5KHZ
- 10KHZ

3. In the **SOUND** menu, press or button to adjust level or select desired setting.
4. Use the buttons to select the various **SOUND** menu items and make your desired adjustments and access the sub-menus.
5. Press button to exit menu from screen.

Sound menu items	Activities
EQUALIZER	Allows you a choice of different sound frequencies.
BALANCE	Increase or decrease to adjust balance level.
AVL (Auto Volume Leveller)	As variation in signal conditions can result a sudden change in volume during FM channel switching, selecting the "ON" function will enable the volume to remain at a standard volume level.
INCREDIBLE SURROUND	Allows you to select between Incredible Surround Dolby Virtual or Stereo sound when transmission is in stereo. Allows you to select between Spatial and Mono sound when transmission is in mono.

USING THE FM RADIO SMART SOUND CONTROL

FM RADIO SMART SOUND feature offers you a choice of 5 sound settings, namely, **ROCK**, **POP**, **CLASSICAL**, **JAZZ**, and **PERSONAL**.

- 1) Press the (**FM RADIO**) button to enter **FM RADIO** mode.
- 2) Press (**SMART SOUND**) button repeatedly to cycle through the various settings and select your desired sound mode.
- 3) Press the (**OSD**) button to exit On-Screen display .





ACCESSING THE FM RADIO FEATURES MENU

ACTIVATING THE TIMER

The Timer feature allows you to set the timer to switch to another FM channel at a specified time while you are listening another FM channel. For the timer to function, the set must not be switched off. Once the set is switched off, the timer is disabled. **Note** : Ensure you are in **FM RADIO** mode before you access **FM RADIO** main menu.

FEATURES

- **TIMER** TIME
- MODE SELECT START TIME
- SCREENSAVER STOP TIME
- CHANNEL
- ACTIVATE

1. Enter **FM RADIO** main menu. 2. Select **FEATURES**. 3. Enter **FEATURES** menu.

Use the Menu and Cursor Up, Down, Right and Left buttons to access the Timer menu to : – select the items. make the following adjustments or activate the timer.

TIME : Use the buttons to key in the current time to enable functioning of the timer feature.

START TIME : Use the buttons to key in the time you want the channel to be switched on.

STOP TIME : Use the buttons to key in the time you want the program to be switched off.

CHANNEL : Use the buttons to key in the FM channel number.

ACTIVATE : Use the Cursor buttons to select between the Once and Daily mode to activate the timer.

DISPLAY : Use the Cursor buttons to select the **ON** option to display current time on screen.

FEATURES
TIMER
• TIME ▲
• START TIME ►► 12:30
• STOP TIME ▼

FEATURES
TIMER
• TIME ▲
• START TIME ►► 13:30
• STOP TIME ▼

FEATURES
TIMER
• TIME ▲
• START TIME ►► 15:30
• STOP TIME ▼

FEATURES
TIMER
• TIME ▲
• START TIME ►►
• STOP TIME ▼
• CHANNEL ►► FM8

FEATURES
TIMER
• TIME ▲
• START TIME ►►
• STOP TIME ▼
• CHANNEL ►►
• ACTIVATE ►► ONCE

FEATURES
TIMER
• START TIME ►►
• STOP TIME ▼
• CHANNEL ►►
• ACTIVATE ►►
• DISPLAY ►► ON



ACCESSING THE FM RADIO FEATURES MENU

USING THE MODE SELECT

This feature allows you to go into **TV**, **HD** or **PC** mode. **Note** : Ensure you are in **FM RADIO** mode before you access **FM RADIO** main menu.

1. Enter **FM RADIO** main menu. 2. Select **FEATURES**. 3. Enter **FEATURES** menu.

FEATURES	
◀ TIMER	TIME
• MODE SELECT	START TIME
• SCREENSAVER	STOP TIME
	CHANNEL
	ACTIVATE

Press Button

Result on Screen

4. Select **MODE SELECT**.
5. Enter **MODE SELECT** menu.
6. Select your desired mode.
7. Enter selected mode.

FEATURES	
• TIMER	TV
◀ MODE SELECT	HD
• SCREENSAVER	PC

FEATURES	
MODE SELECT	
◀ TV	
• HD	
• PC	

Note : You can also access directly the **TV**, **HD** and **PC** modes by the **TV** **HD** **PC** buttons.

ACTIVATING THE SCREENSAVER

Repeat Steps 1 to 3 as in "Using the Mode Select".

4. Select **SCREENSAVER**.
5. Select **ON** option to activate screensaver mode.
6. Exit menu from screen.



FEATURES	
• TIMER	
• MODE SELECT	
◀ SCREENSAVER	ON





FEATURES	
• TIMER	
• MODE SELECT	
◀ SCREENSAVER	▶ ON



ACCESSING THE PC MODE

This TV also allows you use your TV as a PC monitor. To enable you to access PC mode in the TV, you must connect the following :-

- 1 Connect DC input terminal to the AC adaptor.
- 2 Connect the Mains Plug from the AC adaptor to the AC outlet.
- 3 Connect Audio L and R output of your PC to the Audio IN L and R of your TV.
- 4 Press  button to enter into PC mode.
- 5 Press  button to enter into the PC Main Controls Menu.

Using the The 4 buttons , ,  and  (**Cursor Down, Up, Left and Right**) on the remote control allow you to select the desired menu item, make adjustments and access the sub-menus.

The PC Main Controls menu allows you to access for the following menu items :

- **AUDIO SELECTION** Allows audio selection between the PC , TV/Source and FM Radio.
- **BRIGHTNESS and CONTRAST** Allows you to increase or decrease Brightness and Contrast level.
- **ADJUST COLOR** Adjusts the color temperature of the picture. 3 settings are available (Normal, Warm, Cool or Personal).
- **VIDEO NOISE** Allows you to eliminate the vertical bars by using the Clock adjustment of Video Noise. Also allows you to eliminate the horizontal bars by using the Phase Adjustment of VIDEO NOISE in the Main Controls.
- **ADJUST POSITION** Allows you to adjust the horizontal and vertical image position.
- **AUTO ADJUST** Allows you to do automatic adjustments of settings.
- **PIP CONTROLS** Press  (PIP ON/OFF) button to allow you go into PIP mode. PIP Controls allows to change the Size and Position of the subscreen.
- **MODE SELECT** Allows you enter into TV, HD or FM Radio mode.
- **RESET TO FACTORY SETTINGS** Allows you to reset all settings to Default Factory settings
- **VIEW FORMATS** Allows you to choose between Native and Wide Screen formats.



PC DISPLAY SETUP

When you are using the TV as a Computer Display, follow the procedures for PC Display setup.

Note : Different Window versions may give different PC Display setup procedures.

1. Press **PC** (PC) button on the remote control to enter PC mode.
Note : The LCD TV will go on standby mode automatically within 5 seconds if no PC signal is detected.
2. Click on "Settings" on the Window Start menu.
3. Select "Control Panel".
4. Click on "Display" and a display dialog-box will appear.
5. Navigate to the "Settings" tab on the display dialog-box.
6. Select the required "Colours and Resolution" and click "OK".
7. Dialog-box "...Does Not Support..." message will be displayed if set does not support settings.

USING THE PC PICTURE-IN-PICTURE FEATURE

Picture-in-Picture feature allows you to call up a subscreen within your main screen.

How to switch on the Picture-in-Picture Window screen

1. Press **PC** (PC) button on the remote control to enter PC mode.
2. Press the **PIP On/Off** button to switch on Picture-in-Picture screen (A large size PIP screen appears).
3. Press the **PIP On/Off** button a second time to change PIP screen to a medium size.
4. Press the **PIP On/Off** button a third time to change to a small size.
5. Press the **PIP On/Off** button a fourth time to exit PIP screen.

Note : PC mode supports Picture-in-Picture with PC refresh rate not more than 60Hz.

How to position the Picture-in-Picture screen

2. In PC mode, press the **PIP On/Off** button to switch on Picture-in-Picture screen.
3. Press the **PIP Position** button repeatedly to position PIP screen to the position of your choice. (You can choose to position your PIP screen to be on the top left/top right/ bottom right or bottom left hand corner).
4. Press the **PIP On/Off** button three times to exit PIP screen.



PC MODES SUPPORT

Note : If the signal from the system does not equal the PC Modes Support, there may be no video or corrupted video. Proceed to change the system to the right resolution that the PC mode support.

No.	Resolution	Refresh Rate	Vertical Sync	Horizontal Sync	Horizontal Polarity	Pixel Frequency
1	640 x 480	60 Hz	N	31,500 kHz	N	25,175 MHz
2		67 Hz	N	35,000 kHz	N	30,240 MHz
3		72 Hz	N	37,900 kHz	N	31,500 MHz
4		75 Hz	N	37,500 kHz	N	31,500 MHz
5		85 Hz	N	43,300 kHz	N	36,000 MHz
6	720 x 400	70 Hz	P	31,469 kHz	N	28,322 MHz
7	800 x 600	56 Hz	P	35,100 kHz	P	36,000 MHz
8		60 Hz	P	37,900 kHz	P	40,000 MHz
9		72 Hz	P	48,100 kHz	P	50,000 MHz
10		75 Hz	P	46,900 kHz	P	49,500 MHz
11		85 Hz	P	53,700 kHz	P	56,250 MHz
12	832 x 624	75 Hz	P	49,700 kHz	P	57,300 MHz
13	1024 x 768	60 Hz	N	48,400 kHz	N	65,000 MHz
14		70 Hz	N	56,500 kHz	N	75,000 MHz
15		75 Hz	P	60,000 kHz	P	78,750 MHz
16		85 Hz	P	68,700 kHz	P	94,500 MHz
17	1152 x 864	75 Hz	P	67,500 kHz	P	108,000 MHz
18	1280 x 960	60 Hz	P	60,000 kHz	P	108,000 MHz
19	1280 x 1024	60 Hz	P	64,000 kHz	P	108,000 MHz
20		75 Hz	P	80,000 kHz	P	135,000 MHz



ACCESSING THE HD (HIGH DEFINITION) MODE

The HD mode offers you Picture and Sound adjustments, Mode Select and Lock Channel feature.

USING THE HD PICTURE / SOUND MENU

The HD Picture and Sound menus allow you to make adjustments to the picture and sound. It also allow you to select and activate other features in the menu.

1. Press the **(HD)** button to enter HD mode.
2. Press the **(MENU)** button to enter main menu.
3. Use the **(CURSOR UP/DOWN)** buttons to select the items on the **HD PICTURE/SOUND** menu.
4. Use the **(CURSOR LEFT/RIGHT)** buttons to access the sub-menus.

Picture menu items	Activities
Brightness	Increase or decrease brightness level.
Color	Increase or decrease color level.
Contrast	Increase or decrease contrast level until lightest parts of the picture show good detail.
Sharpness	Increase or decrease sharpness level to improve detail in the picture.
Hue	Increase or decrease hue level
Color Temp	Allows you a choice of 3 picture settings (NORMAL, WARM and COOL).
Format	Allows you to choose between FULL SCREEN and WIDE SCREEN formats.

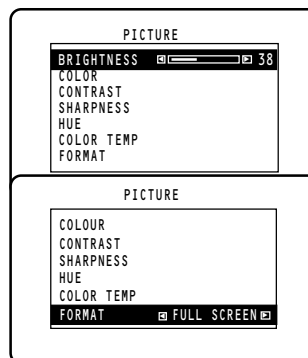

Note : HUE feature is only applicable to NTSC programmes. The HUE item will not appear on the menu if programme is in PAL mode.



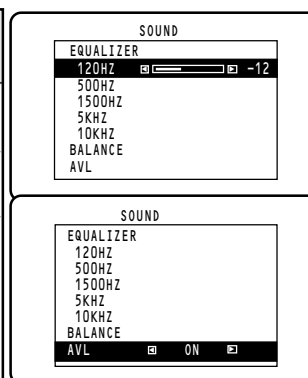



Sound menu items	Activities
Equalizer	Allows you a choice of different sound frequencies.
BALANCE	Increase or decrease to adjust balance level.
AVL (Auto Volume Leveller)	As variation in signal conditions can result a sudden change in volume during in commercial breaks or channel switching, selecting the "ON" function will enable the volume to remain at a standard volume level.



ACCESSING THE HD (HIGH DEFINITION) MODE

USING THE HD MODE SELECT



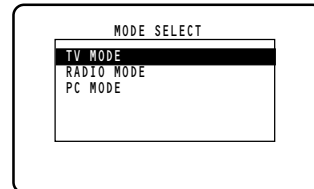
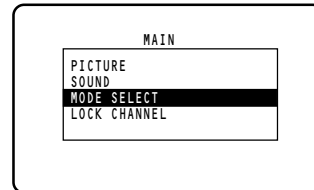

The **HD MODE SELECT** feature allows you to switch to **TV MODE**, **FM RADIO MODE**, or **PC MODE**.

1. In HD mode, press the  (**MENU**) button to enter HD main menu.
2. Press the  (**CURSOR DOWN**) button repeatedly until **MODE SELECT** is highlighted.
3. Use the  (**CURSOR /RIGHT**) button to **MODE SELECT** menu
4. Use the   (**CURSOR UP/DOWN**) buttons to select **TV MODE**, **FM RADIO MODE** or **PC MODE**.
5. Press  (**CURSOR RIGHT**) button to activate selected HD mode.



USING THE HD LOCK CHANNEL

The **HD LOCK CHANNEL** feature allows you to lock the HD mode channel to censor the viewing of programme not suitable for children.

1. In HD mode, press the  (**MENU**) button to enter main menu.
2. Use the  (**CURSOR DOWN**) button repeatedly until **LOCK CHANNEL** is highlighted..
3. Use the  (**DIGIT**) buttons to enter the four digit Access Code to set up the **LOCK CHANNEL** function.
4. Use the  (**CURSOR /RIGHT**) button to select **ON** or **OFF** options. If **ON** option is selected, the HD channel will not allow viewing of programmes.
5. Press  (**OSD**) button to exit menu from screen.

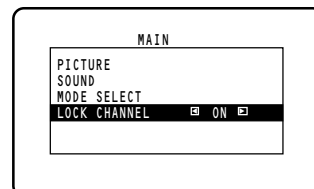
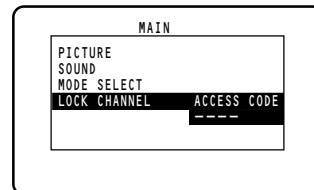



BEFORE CALLING SERVICE (TV MODE)

Below is a list of frequently occurred symptoms. Before you call for service, make these simple checks. Some of these symptoms can easily be rectified if you know what to do.

Symptom

No power

What you should do

- Check whether adaptor is connected properly into cinch.
- Check the TV's AC power cord is plugged into the mains socket. If there is still no power, disconnect plug. Wait for 60 seconds and re-insert plug. Switch on the TV again.

No picture

- Check whether transmission is in TV mode. Press  (TV button) on remote control to confirm.
- Check the antenna connection at the rear of the TV.
- Possible TV station problem. Try another channel.

Good picture but no sound

- Try increasing the volume.
- Check that the sound is not muted. If it is muted, press the **Mute** button on the remote control to restore sound.
- Check that your headphone is not connected.

Good sound but poor colour or no picture

- Try increasing the contrast and brightness setting.

Snowish picture and noise

- Check antenna connection at the rear of the TV.

Horizontal dotted lines

- Possible electrical interference e.g. hairdryer, vacuum cleaner, etc. Switch off appliances.

Double images or "Ghost" images

- Possible poor positioning of antenna. Using a highly directional antenna may improve reception.

TV not responding to remote control handset

- Check life span of batteries of remote control handset.
- Aim remote control handset directly at remote control sensor lens on the TV.

An after-image appears

- If an image remains in the screen for an extended period of time, it may be imprinted in the screen and leave an after-image. This usually disappears after a few hours.

An after-image remains after the power has been turned off

- This is characteristic of liquid crystal and is not caused by a malfunction or deterioration of the liquid crystal. This after-image will disappear after a set amount of time.



BEFORE CALLING SERVICE (PC / FM RADIO MODE)

Below is a list of frequently occurred symptoms when you are in PC /FM RADIO mode . Before you call for service, make these simple checks. Some of these symptoms can easily be rectified if you know what to do.

Symptom

What you should do

Incorrect Display position

- Adjust the image position using the Horizontal Position and/ or Vertical Position in the PC Mains Controls menu.

No Video Input

- Make sure the monitor cable is properly connected to the PC input (VGA) at the rear of the TV.
- Check whether the monitor cable has bent pins.

Vertical flicker appears

- Try eliminating the vertical bars by using the Clock Adjustment of VIDEO NOISE in the Main Controls.

Horizontal flicker appears

- Try eliminating the horizontal bars by using the Phase Adjustment of VIDEO NOISE in the Main Controls.

Screen too bright or dark

- Try adjusting the contrast and brightness in the Main Controls.

Cannot access FM radio

- Check whether the connection from FM Antenna socket to the FM Radio mains is done correctly.



SPECIFICATIONS

	17PF9945	23PF9945
Picture tube screen size	432 mm	584 mm
Audio Output	2 x 3 W	2 x 5 W
TV System	NTSC M PAL B/G PAL D/K PAL I SECAM B/G SECAM D/K SECAM K1	
Playback System	NTSC 3.58, NTSC 4.43, PAL 60	
Set Dimensions without stand		
Length	517 mm	704 mm
Height	301 mm	373 mm
Depth	65 mm	76 mm
Set Dimensions with stand		
Length	517 mm	704 mm
Height	340 mm	419 mm
Depth	177 mm	195 mm
Net Weight of Set with stand	6.4 kg	9.9 kg

Note

For Operating Voltage, Frequency, Power Consumption and Version Number, refer to the type number on mains adaptor.



3139 125 30942

51



17/23PF9945/69 p39-51

51



8/25/03, 5:31 PM

